

thanos EVO RS485 BACnet

Room operating unit temperature, optional with humidity | CO2 | VOC

thermokon[®]
HOME OF SENSOR TECHNOLOGY

Datasheet

Subject to technical alteration
Issue date: 05.02.2024 • A131

thanos **EVO**
ASHRAE **BACnet**[™]



» APPLICATION

Room control unit with room temperature measurement, optional humidity, CO2, or VOC and a monitoring function for colourful visualization of the measured values. The maintenance-free sensor creates the conditions for a pleasant indoor climate and well-being. Typical applications are schools, office buildings, hotels or cinemas. The room control unit has a high-resolution 4.8" display with a noble glass surface. The innovative and self-explanatory operation offers the functions of light, shading, climate and scene control for intelligent room automation.

» TYPES AVAILABLE

Touch screen room operating unit temperature + opt. humidity, CO2, VOC – active BUS

- thanos EVO Temp RS485 BACnet
- thanos EVO Temp_rH RS485 BACnet
- thanos EVO CO2 Temp_rH RS485 BACnet
- thanos EVO VOC Temp_rH RS485 BACnet
- thanos EVO CO2+VOC Temp_rH RS485 BACnet

** also available as design variant*

» SECURITY ADVICE – CAUTION

The installation and assembly of electrical equipment should only be performed by authorized personnel.



The product should only be used for the intended application. Unauthorised modifications are prohibited! The product must not be used in relation with any equipment that in case of a failure may threaten, directly or indirectly, human health or life or result in danger to human beings, animals or assets. Ensure all power is disconnected before installing. Do not connect to live/operating equipment.

Please comply with

- Local laws, health & safety regulations, technical standards and regulations
- Condition of the device at the time of installation, to ensure safe installation
- This data sheet and installation manual

» PRODUCT TESTING AND CERTIFICATION



Declaration of conformity

The declaration of conformity of the products can be found on our website
<https://www.thermokon.de/direct/en-gb/categories/thanos-evo>

» BUILD-UP OF SELF-HEATING BY ELECTRICAL DISSIPATIVE POWER

Sensors with electronic components always have a dissipative power, which affects the temperature measurement of the ambient air. The dissipation in active temperature sensors shows a linear increase with rising operating voltage. This dissipative power has to be considered when measuring temperature. In case of a fixed operating voltage ($\pm 0,2$ V) this is normally done by adding or reducing a constant offset value.

Thermokon transducers can be operated with variable operating voltages. The transducers are set at the factory with a reference operating voltage of 24 V =.

At this voltage, the expected measuring error of the output signal will be the least. Other operating voltages, can cause a measurement deviation changing power loss of the sensor electronics.

A recalibration can be carried out directly on the unit or via a software variable (app or bus).

Remark: Occurring draught leads to a better carrying-off of dissipative power at the sensor. Thus temporally limited fluctuations might occur upon temperature measurement.

» MOUNTING ADVISE ROOM SENSORS

The Accuracy of the room sensors are influenced by the technical specifications as well as the positioning and the installation type.

During Assembly:

- Seal mounting box (if present).
- Installation type, air draught, heat source, radiation heat or direct sunlight can affect the measurement.
- Bulding material specific properties of the installation place (*brick-, concrete-, partition wall, cavity wall, ...*) can affect the measurement. (*e.g.: Concrete accepts room temperature variation slower than cavity walls*)

Assembly not recommendet in...

- Air draught (e.g.: close to windows / doors / fans ...)
- Near heating sources,
- Direct sunlight
- Niches / between furniture / ...

» APPLICATION NOTICE FOR HUMIDITY SENSORS

At regular environmental condition, it is recommended to calibrate the sensor annually to check the compliance with the accuracy required in the application. The following conditions can damage the sensor element or lead in long term to loss of the specified accuracy:

- Mechanical stress
- Contamination (e.g. dust / fingerprints)
- Aggressive chemicals
- Ambient conditions (e.g. condensation on measuring element)



Do not touch the sensor elements!

Re-calibration or exchange of the sensor element are not subject of the general warranty.

» INFORMATION ABOUT SELF-CALIBRATION FEATURE CO2

All gas sensors are subject to drift. The degree of drift is dependent on the use of components and product design. In addition, the following environmental conditions, among others, can accelerate/ favor the aging and wear of the sensors:

- Mechanical stress (also due to temperature fluctuation)
- Contamination (dust / fingerprints e.g.)
- Abrasive chemicals
- Environmental influences (high humidity / condensation on measuring element)

An internal self calibration function with dual channel technology compensates the caused drift. Thermokon sensors are for permanent use (e.g. hospitals).

» INFORMATION ABOUT INDOOR AIR QUALITY CO2

EN 13779 defines several classes for indoor air quality:

Category	CO ₂ content above the content in outdoor air in ppm		Description
	Typical range	Standard value	
IDA1	<400 ppm	350 ppm	Good indoor air quality
IDA2	400.. 600 ppm	500 ppm	Standard indoor air quality
IDA3	600..1.000 ppm	800 ppm	Moderate indoor air quality
IDA4	>1.000 ppm	1.200 ppm	Poor indoor air quality

» APPLICATION NOTICE FOR AIR QUALITY SENSORS VOC

Volatile organic compounds (VOC) are gaseous and vaporous substances of organic origin in the air. VOC-sensors monitor the significant part of humanly olfactory sensed air quality. (e.g. body odor | tobacco smoke | odor of materials, furniture, carpets, paint, adhesives, ...)

The VOC-Value is an application-specific indication for air quality and doesn't provide any information about individual components of VOC

A VOC sensor oxidises the organic molecules that collide with it, which results in changing the resistance of the semiconductor.

Any contact with the sensitive sensors must be avoided and will invalidate the warranty.

The VOC Sensor is factory calibrated and can be calibrated via NOVOSapp subsequently, if needed.

» TECHNICAL DATA

Measuring values	temperature, optional humidity CO ₂ VOC
Network technology	RS485 BACnet, Fail-safe Biasing required
Power supply	24 V = (±10%) or 24 V ~ (±10%) SELV <i>With alternating voltage, the correct polarity must be ensured.¹</i>
Power consumption	typ. 2,5 W (24 V =) 5 VA (24 V ~)
Measuring range temperature	0..+100 0..+150 +40..+90 +40..+140 °F, default setting: +40..+140 °F, optionally configurable via Thermokon NOVOSapp or BUS
Accuracy temperature	±0,5K (typ. at 70 °F)
Inputs	1x input for floating contact
Control functions	occupancy signalling, light ON/OFF/DIM, setup scenarios, blinds UP/DOWN/SET, fan stages, setpoint, ECO function, measured value display & history
Display	TFT 4,8", 1120x480 px, capacitive touch technology
Enclosure	PC V0 and glass, Design surface glass, white or black
Protection	IP30 according to DIN EN 60529
Cable entry	rear entry, breaking points bottom, drill mark top
Connection electrical	tool-free mountable spring terminal, max. AWG16
Ambient condition	-32..+122 °F, max. 85% non-condensing
Mounting	surface mounted on flush-mounting box (Ø=2.36 in. 60 mm) or to be mounted flat onto the surface using screws, base part can be mounted and wired separately

¹ When several BUS devices are supplied by one 24 V AC voltage supply, it is to be ensured that all "positive" operating voltage input terminals (+) of the field devices are connected and all "negative" operating voltage input terminals (-) (=reference potential) are connected (in-phase connection of field devices). In the case of reversed polarity at one field device, a supply voltage short-circuit would be caused by that device.

The short-circuit current thus flowing through this field device will damage it. Therefore, pay attention to the correct wiring.

» Humidity (optional)

Measuring range humidity (optional configurable)	relative humidity (default) 0..100% rH	Enthalpy 0..37 BTU/lb	absolute humidity 0..1,5 0..2,3 g/ft ³	dew point +32..+122 -4..+176 °F
	configurable via Thermokon NOVOSapp or BUS			
Accuracy humidity	±2% between 10..90% rH (typ. at 70 °F)			

» CO₂ (optional)

Measuring range CO ₂	0..2000 0..5000 ppm (configurable via Thermokon NOVOSapp or BUS)
Accuracy CO ₂	±(50 ppm +3 % of reading), (typ. at 70 °F, 50% rH, 1015 hPa)
Calibration	self-calibration dual channel
Sensor	NDIR (non-dispersive, infrared)

» VOC (optional)

Measuring range VOC	0..100 %
Calibration	self-calibration
Sensor	VOC sensor (heated metal oxide semiconductor)

» CONNECTION PLAN

Room operating unit – active RS485 BACnet

thanos EVO RS485 BACnet

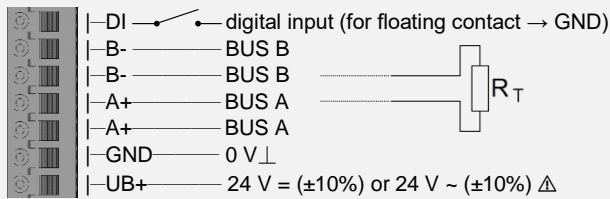

With alternating voltage, the correct polarity must be ensured! Please note the technical data.

Don't forget the BUS termination (120 Ω) at the last device of the line!
(Not included in delivery)

» MOUNTING ADVICES

Cable entry

There are predetermined breaking points for 2 optional cable entries on the underside of the base plate.

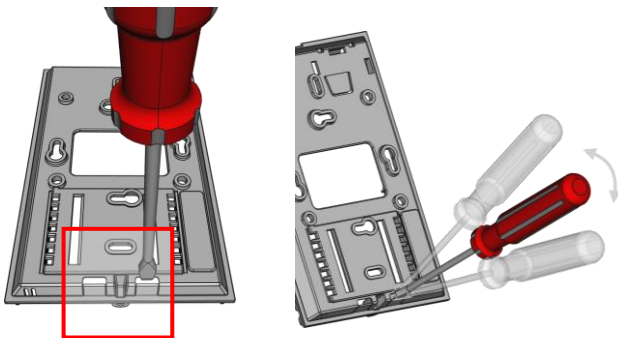

Please make sure that the device is de-energized if you want to install it!

The installation can be performed on the flat wall surface or on a flush-mounted box. A representative place should be selected. Sunshine and draft, e.g. in the installation tube should be avoided, so that the measurement result is not falsified. Seal the end of the installation tube.

- For wiring, the upper part of the device must be removed from the base plate. Base plate and upper part are detachably connected to each other by means of locking lugs.
- The mounting of the base plate on the flat wall surface is done with rawplugs and screws.
- Finally, the device is attached to the base plate and fixed with the screw.

Housing open / close

Snap the upper part of the housing into the locking lug on the upper side

Fix the upper part of the housing on the underside with the screw

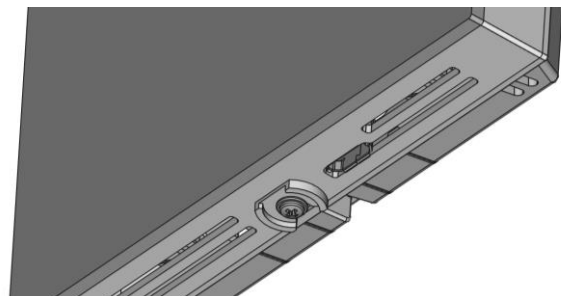
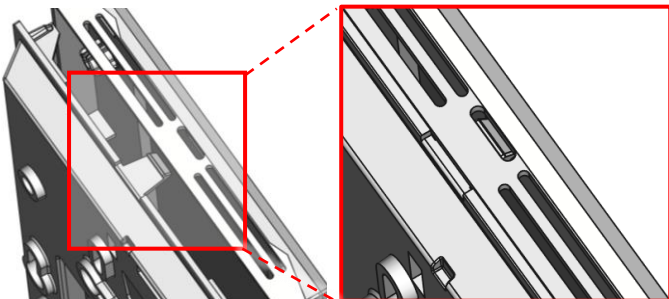

» NOTES ON DISPOSAL



The crossed-out wheeie bin symbol indicates that the product or removable batteries must not be disposed of with household or commercial waste. Within the EU, you are legally obliged to dispose of the product separately and appropriately in accordance with the national laws of your country. Alternatively, please contact your supplier or Thermokon Sensortechnik GmbH. Further information can be found at: www.thermokon.com

» FUNCTION DESCRIPTION – HOMESCREEN THANOS EVO

Home screen
 The display on the main screen of the NOVOS room control unit can be freely parameterised. All icons and notifications can be switched on and off. Set point can also be overwritten.



Headline
 In the header of the main screen various icons can be shown or hidden as desired.

Date / time
 The time and date are in the center of the main screen.

Setpoint / room temperature
 The currently set target value of the room control unit and the room temperature are shown on the display.

Navigation bar
 The navigation bar is a central element on the Home screen. It contains all menus such as climate, light, blinds, scene, monitoring, display ON/OFF and settings. If certain menus are not needed, they can be switched off as desired. With a swipe gesture you can scroll between the menu pages in the navigation bar.



Status messages
 At any time, any text message (max. 24 characters) can be displayed on the main screen for status reporting or notification.

Favorites button
 Light, blind circles or complete submenu can be placed on the home screen as a favourites button that is quickly accessible. Up to 4 favourite buttons are possible.
Example below: 4 different Light circles



To reduce the risk of burnt-in effects of the screen contents, it is recommended to activate the screen saver. By default, the screen saver switches on 120 seconds after the last interaction.





BACnet Objects, PICS und BIBBs
 NOVOS-RS485 BACnet Interface

A detailed description of the BACnet interface can be found under the following link: → [Download](#)

» CONFIGURATION

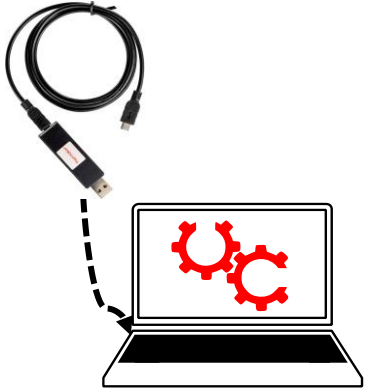
The configuration is performed in powered state. The following options are available for configuring the device:

Device connection	Micro-USB	Micro-USB
Configuration-adapter	<p>Thermokon USB-Interface</p> 	<p>USB-Bluetooth Dongle</p> 
Configurations-software	<p>PC/Notebook with uConfig software</p> <p>Partly parameterization with Thermokon software uConfig, via Thermokon USB-Interface* (Art.-No.: 597838)</p>	<p>Smartphone/Tablet with NOVOS App</p> <p>Parameterization with mobile device via bluetooth and NOVOSapp. Separately available Bluetooth Dongle* required: (Art.-No.: 668262)</p>

*Commercially available Bluetooth dongles or USB to Micro-USB adapter cables are not compatible. You need a mobile device that supports at least Bluetooth version 4.1. The configuration app with the corresponding instructions can be downloaded from the Google Play Store or the Apple App Store.

Additionally a configuration via RS485 interface via BMS during powered state is possible.

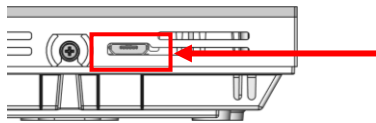

Position of the micro USB port, see bottom of the device, for configuration with Bluetooth dongle or Micro-USB programming interface

» DIMENSIONS MM (IN.)

» ACCESSORIES (OPTIONAL)

Rawplugs and screws (2 pcs. each)
 PSU-UP24 – flush mount power supply 24 V (AC Input: 100..240 V ~ | DC Output 24 V = 0,5 A)

Bluetooth dongle
 USB-Interface RS485 incl. Driver
 Thermokon USB-Interface
 RS485 Biasing Adapter

Item No. 102209
 Item No. 645737

Item No. 668262
 Item No. 668293
 Item No. 597838
 Item No. 811378

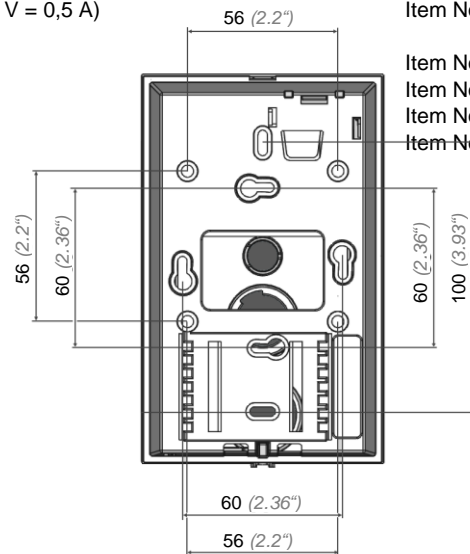
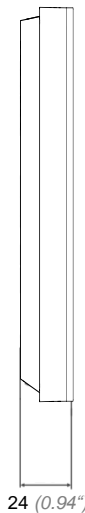
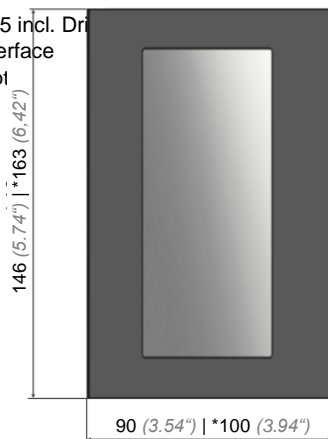

* Thanos Evo Design Dimensions